



**Rock Hog<sup>®</sup> Drilling Products**

**RH50HP SERIES  
DTH HAMMERS**

**OPERATION & MAINTENANCE MANUAL  
FOR MODELS: RH50Q\_HP, RH50R\_HP**

MANUAL No HW-49030



Web Site @ [www.rockhog.com](http://www.rockhog.com)  
E-Mail Address: [sales@rockhog.com](mailto:sales@rockhog.com)

# Table of Contents

<b>SECTION 1. GENERAL INFORMATION .....</b>	<b>2</b>
<b>1.1 Description .....</b>	<b>2</b>
<b>1.3 Air Supply .....</b>	<b>2</b>
<b>1.4 Unpacking a New Hammer .....</b>	<b>2</b>
<b>SECTION 2. HAMMER OPERATION.....</b>	<b>3</b>
<b>2.1 Lubrication of Internal Parts .....</b>	<b>3</b>
<b>2.2 Lubrication of Threaded Connections .....</b>	<b>3</b>
<b>2.3 Hole Cleaning .....</b>	<b>3</b>
<b>2.4 Setting the Choke .....</b>	<b>3</b>
<b>2.5 Effect of Elevation .....</b>	<b>4</b>
<b>2.6 Water Injection.....</b>	<b>4</b>
<b>2.7 Drilling Under Water .....</b>	<b>4</b>
<b>2.8 Drill Pipe/Changing Pipe.....</b>	<b>4</b>
<b>2.9 Function of Parts.....</b>	<b>4</b>
<b>2.10 Installing the Bit .....</b>	<b>5</b>
<b>2.11 Connect the Hammer .....</b>	<b>5</b>
<b>2.12 Drilling .....</b>	<b>5</b>
<b>2.13 The Drill Bit .....</b>	<b>6</b>
<b>2.14 Breaking Threads Loose.....</b>	<b>6</b>
<b>2.15 Monitoring.....</b>	<b>7</b>
<b>2.16 Storage.....</b>	<b>7</b>

<b>SECTION 3. MAINTENANCE .....</b>	<b>8</b>
<b>3.1 Schedule.....</b>	<b>8</b>
<b>3.2 Disassembly .....</b>	<b>8</b>
<b>3.3 Inspection .....</b>	<b>10</b>
<b>3.4 Assembly.....</b>	<b>11</b>
<b>SECTION 4. PARTS BREAKDOWN.....</b>	<b>14</b>
<b>Exploded View, model RH50Q1HP .....</b>	<b>14</b>
<b>Assembled View .....</b>	<b>14</b>
<b>Part List, Model RH50Q1HP .....</b>	<b>15</b>
<b>Exploded View, model RH50R1HP .....</b>	<b>16</b>
<b>Assembled View .....</b>	<b>16</b>
<b>Part List, Model RH50R1HP .....</b>	<b>17</b>
<b>SECTION 5. TROUBLE SHOOTING.....</b>	<b>18</b>

## Section 1. General Information

### 1.1 Description

The RH50HP hammer is a valveless pneumatic percussion hammer for drilling in all rock formations. It is designed for waterwell, blast holes, and construction when drilling 5" to 6" holes. The 50HP incorporates one moving part, the piston, making the hammer very reliable. The HP hammer is designed with a more efficient air cycle for improved performance. All external parts are hardened to resist wear while all critical internal parts are also hardened for maximum service life. The simple design also makes the hammer easy to maintain and service.

### 1.2 SPECIFICATIONS

	English	Metric
<b>Outside Dia</b>	4.53 in	115 mm
<b>Overall Length Without Bit</b>		
RH50Q models	47.2 in	1199 mm
RH50R models	48.2 in	1222 mm
<b>Operating Length API shoulder to Bit Face</b>		
RH50Q models	47.1 in	1196 mm
RH50R models	48.1 in	1222 mm
<b>Total Weight</b>	139 lbs	63 kg
<b>Bore Size</b>	3.71 in	94.2 mm
<b>Piston Weight</b>	30 lbs	13.6 kg
<b>Drillpipe Connect</b>	3-1/2 Reg API Pin Up others available upon request	
<b>Wrench Flats</b>	3.5 in	88.9 mm
<b>Hole Size Range</b>	5 in to 6 in 127 mm to 152 mm	
<b>Bit Shank Required</b>		
RH50Q models	QL50	
RH50R models	350R	
<b>Minimum Air Volume Required</b>	250 cfm	7 cmm
<b>Maximum Operating Pressure</b>	500 psi	34 bar

### 1.3 Air Supply

A minimum of 250 cfm is recommended to be supplied to the hammer up to air supplies of 1000 cfm. The hammer will function on lower supplies but the penetration rate will be very slow. For the fastest possible penetration, the hammer should be operated

at the highest obtainable pressure for the given air supply. A maximum pressure of 380 psi is recommended. Operating at pressures up to 500 psi is acceptable and will increase penetration rates but will also shorten the service life of both internal and external hammer parts and also wear the bit out faster.

The chart below shows the hammer's operating pressure for a given air volume supply based on operation at sea level. If a large air volume is supplied, the choke will need to be opened to maintain the desired max psi. The choke adjustment is explained in section 2.4.

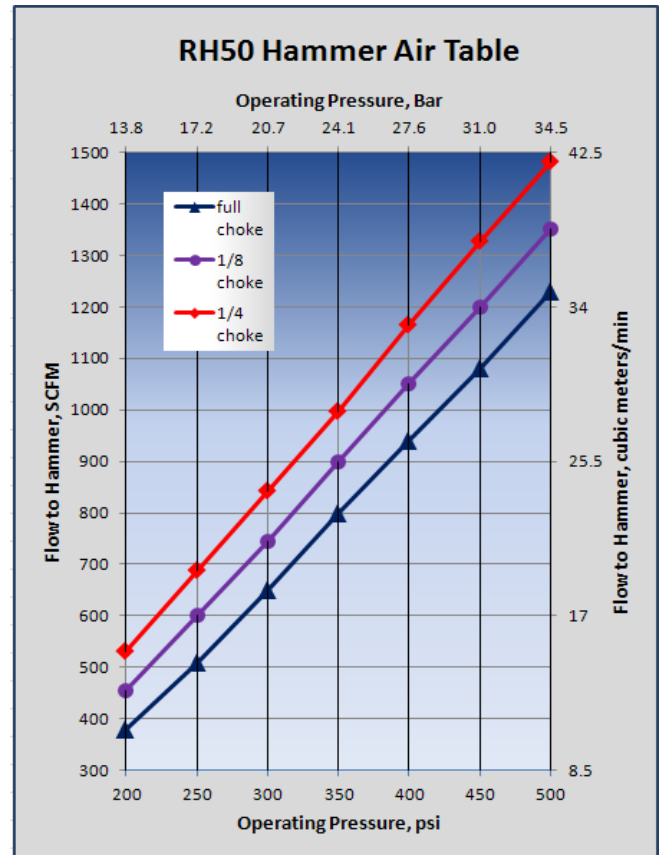

### 1.4 Unpacking a New Hammer

First make note of the hammer Part Number & Serial Number found on the ID label on the outside of the hammer shipping tube and also on the wearsleeve of the hammer. Your Rock Hog representative will need these numbers if you have questions on the hammer. The 12-digit hammer serial number is the backhead & air distributor serial numbers put together.

Once the hammer has been unpacked, **locate and keep** the (2) steel rings. These are needed when servicing the hammer. Remove the plastic bag attached to the backhead. This bag contains 2 optional chokes. Keep these chokes for possible future use.

If you plan to service the hammer yourself, see section 3.4.4 to obtain, at NO CHARGE, a set of assembly rings if you don't already have some.

## Section 2. Hammer Operation

### 2.1 Lubrication of Internal Parts

The hammer must have a constant and adequate supply of oil to prevent part wear, corrosion, and failure. Rock Hog recommends Mobil ALMO series, Chevron VISTAC series or an equivalent grade. Contact your local lubricant representative for the proper grade to use for your drilling environment and temperatures.

Make sure the oil injector is filled and working properly. Always verify that there is oil coming through the drill string, **DO NOT RUN THE HAMMER WITHOUT CONSTANT OIL INJECTION! THE HP HAMMERS REQUIRE MORE OIL THAN THEIR PREDECESSORS.**

Set the system to inject 1.3 pints per hour for every 300 cfm of air supply. Example, if the supply is 950 cfm, inject  $950/300 \times 1.3 = 4.2$  pints per hour. Again this is more oil than the older models.

Oil Properties			
Mobil ALMO Grade	525	529	532
Chevron VISTAC Grade	ISO46	ISO 150	ISO 320
When to use	winter	summer	summer, production drilling
ISO viscosity grade	46	150	320
SAE viscosity grade	20W-20	30	50
Viscosity			
cSt @ 40°C, ASTM D 445	44	144	310
cSt @ 100°C	6	14	22
SUS @ 100°F, ASTM D 2161	228	755	1660
SUS @ 210°F	48	75	112
Flash Point			
°C	210	220	220
°F	410	450	450

### 2.2 Lubrication of Threaded Connections

All threaded connection must be coated with a no-gall grease. Both the backhead and the chuck thread into the wear sleeve. The hammer is shipped with grease on both connections. All drill pipe connections must also be coated. **When applying grease, be careful not to**

**put grease where it will enter the air stream. The grease will not blow through the hammer but stick to the internal parts. Excessive grease in the hammer will close the airways and stop the hammer.**

Use a high performance copper based grease. Rock Hog recommends **Bestolife** brand, type **Copper Rock** or an equivalent.

### 2.3 Hole Cleaning

For proper hole cleaning, verify that an adequate up-hole air velocity can be obtained. An annular velocity of 3000 feet-per-minute or more is required. Use this formula to check what the velocity will be:

$$\text{Velocity (fpm)} = \frac{(183) \times (\text{supply CFM})}{(\text{bit size})^2 - (\text{drill pipe size})^2}$$

### 2.4 Setting the Choke

The choke is used to match the hammers operating pressure to the air supply. The hammer is shipped with a full choke installed. Two optional open chokes are shipped with the hammer.

For top performance, the operating pressure should be set at the compressor's rated output. The maximum recommended operating pressure is 380 psi but can be run up to 500 psi. Operating over 380 will increase penetration rates but reduce service life.

An open choke creates a controlled air leak in the hammer while the full choke allows no air leak. The larger the choke opening the greater the volume of lost air, the lower the hammer operating pressure.

To determine what choke should be in the hammer, plot your air supply, cfm & psi, on the chart in Section 1.3. From this point, move straight up the chart. The 1<sup>st</sup> choke line reached is the choke that should be used. The hammer is supplied with the full choke installed. To change the choke, remove the backhead, pull out the check valve and with a hammer and punch, drive out the current choke and drive in the needed choke. **On open chokes, the flat goes toward the bit.**

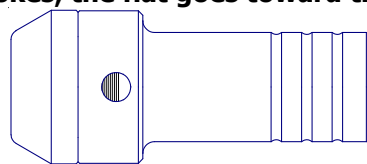

The actual operating pressure of your hammer may vary from the chart in Section 1.3 due to elevation from sea level (see section 2.5), leaks in the air supply line, and actual compressor output compared to its rating.

It is possible to fine-tune the choke opening if needed. If the full choke is in and the operating

pressure is below the compressor's rated output, the only way to increase the operating pressure is to increase the air volume supply. If a factory supplied open choke is being used and the operating pressure is below the compressor's rated output, it is possible to bring the operating pressure up to the rating by taking the full choke and making a flat on it that is smaller than the current open choke.

## 2.5 Effect of Elevation

Elevation above sea level affects the compressor output. As elevation increases, the compressor's volume output decreases. Use the table below to determine volume loss.

Elevation Correction Factor	
Actual Compressor Output = Rated Output x ECF	
Elevation in Feet	ECF
4000	0.86
5000	0.82
6000	0.79
7000	0.76
8000	0.73
9000	0.70
10000	0.68
11000	0.65
12000	0.63
13000	0.61
14000	0.59
15000	0.57

## 2.6 Water Injection

Injecting water into the air supply is a common practice to keep down dust and to improve hole cleaning in soft formations. **ALWAYS USE A CLEAN SUPPLY OF WATER.**

Water injection will increase the hammer operating pressure but reduce the service life of the internal parts. Therefore, use just enough water for the drilling conditions present.

When drilling is complete, always shut off the water and blow air and oil through the drill string to remove the water and coat internal surfaces with oil. This will help prevent surface corrosion of the steel.

## 2.7 Drilling Under Water

The hammer is equipped with a check valve that closes when the air supply is shut off. This maintains air pressure inside the hammer and prevents water from coming up into the hammer.

Drilling under water increases the backpressure. The higher the head of water the greater the backpressure, the slower the hammer will penetrate. A point can be reached where the up-hole velocity is insufficient to overcome the water head and the piston will stop. When needed, performance can be improved by opening the choke. This diverts air from the piston to help blow the water out of the hole.

## 2.8 Drill Pipe/Changing Pipe

The drill pipe must be kept clean and straight. Dirt and rust blown out of the drill pipe and into the hammer will damage the hammer's internal parts.

**Always cover the hole in the drill pipe when doing a pipe change. Always blow out the pipe before connecting it to the drill string. Never allow dirt to fall into the open pipe.**

## 2.9 Function of Parts

To follow is a general description of the function of each of the major components in the hammer:

**Backhead:** connects the hammer to the drill string, closes and seals top of hammer, compresses the spring pack, forms check valve seat, transfers rotational torque to sleeve.



**Breakout washer:** is clamped between the backhead/wearsleeve and chuck/wearsleeve. Reduces the torque required to break the backhead/chuck thread loose.



**Check valve:** pushes open when air is supplied to hammer, closes by seating on backhead when air supply to hammer is cut off, when closed prevents water from flooding up into hammer if water is present.



**Check valve spring:** helps to push check valve closed when air supply to hammer is cut off.



**Choke pin:** is pressed into cross-hole in check valve, used to adjust hammer's air consumption to compressor's output, see section 2.4 in manual.



**Spring pack:** prevents axial movement of the air distributor/cylinder by applying a controlled force against the air

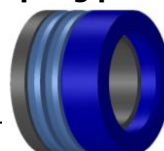

distributor, force is developed by compression of the disc springs.

**Air distributor:** distributes air to cylinder supply ports, houses check valve and spring, controls air cycle.

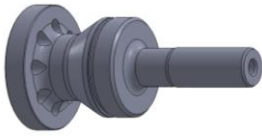

**Cylinder:** guides top of piston, supplies air into piston area, controls air cycle, contains blow-by valve.



**Piston:** the only moving part cycles up and down to hammer on bit, controls air cycle.

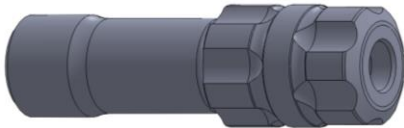

**Wear Sleeve:** houses and locates all other parts, controls air cycle, transfers rotational torque to chuck.



**Bearing:** keeps top of bit centered inside sleeve (note- there may or may not be a bearing, it depends on the bit shank used in hammer).



**Bit retaining ring:** keeps bit from dropping out of hammer when bit is off-bottom.



**Chuck:** keeps bit retainer ring inside sleeve, transfers rotational torque from sleeve to bit, keeps bit in correct axial location.



**Bit:** transfers piston hammer energy thru buttons to rock causing rock fracturing, controls air cycle.

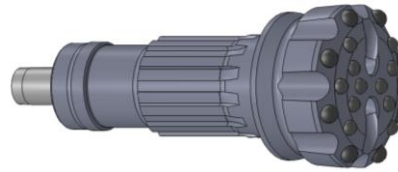

## 2.10 Installing the Bit

The bit can be installed into the hammer on or off the rig. Remove the chuck first then the bit retainer ring. Apply a coating of no-gall grease to the bit splines. Set the chuck down over the bit shank. Pull the two halves of the ring apart and put the ring down over the shank. Put the halves together and set the ring on the chuck. Coat the threads with no-gall grease. Thread the chuck back into the wear sleeve.

## 2.11 Connect the Hammer

If the hammer is new, take a clean rod and push the check valve open and pour about a pint of rock drill oil down the center hole in the backhead.

Once on the rig, tighten both the chuck and backhead before starting the hammer. When tight, there should be no gap between the chuck & sleeve shoulders or between the backhead & sleeve shoulders. ALWAYS USE A WRAP-AROUND WRENCH TO GRIP THE WEAR SLEEVE.

Once the hammer is connected, check the travel of the bit. In the drilling position, the bit should shoulder on the chuck and when the hammer is pulled up, the QL5 bit should drop out 1.2" (30mm), the 350 bit should drop 1.8" (46mm).

## 2.12 Drilling

With the hammer/bit up off the bottom of the hole, supply air to the hammer. The air will blow through the hammer but the piston will not cycle. This allows for continuous blowing to clean out the hole when needed.

Start rotation of the drill string and lower the hammer/bit onto the bottom of the hole. As the bit pushes into the hammer, the piston will begin to cycle and the pressure will build to its normal operating level.

Once a consistent formation is being drilled, set the rotation speed and hold down pressure. As a starting point, use a rotation speed shown in the chart below.

Set the hold down weight on the bit. As a starting point, the weight should be 2000 lb to 3000 lb. Keep in mind that as the hole goes deeper, the weight on the bit increases. Eventually hold back is needed to keep excessive weight off the bit.

Only driller experience will determine what RPM and bit weight combination work best in a given formation. In general, too slow a RPM results in slow penetration

and shortened bit life but too fast a RPM will also shorten bit life. Excessive weight on the bit will cause bit button failure. Insufficient weight causes the piston blow energy to be dissipated into the bit and piston, which will lead to steel failure of these parts.

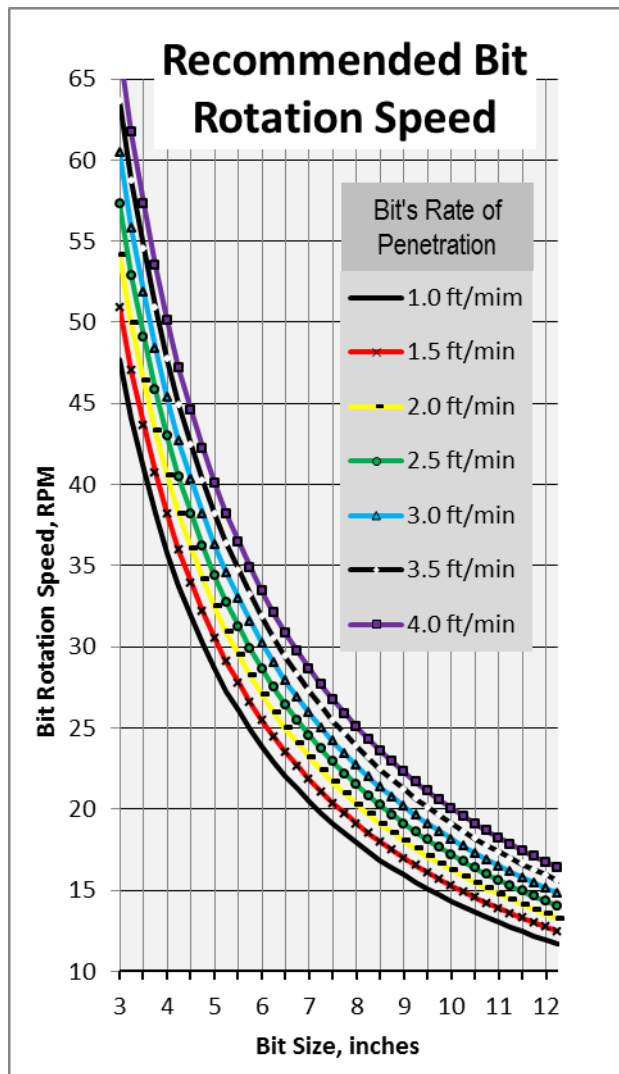

### 2.13 The Drill Bit

A quality Rock Hog hammer requires a quality bit. Rock Hog recommends using the proven Rock Hog line of DTH bits. A full range of sizes and face styles are available through your Rock Hog representative.

The bit is what carries the hammer piston energy to the rock therefore the condition of the bit cutting face should be checked after the completion of each hole drilled.

As the bit accumulates drill time, the buttons and steel will start to show a wear pattern. The pattern and

rate of wear will vary greatly depending on the formation being drilled.

In soft formations such as limestone where the bit wears slowly, watch the buttons for "snakeskin" on the surface. These surface cracks must be ground off to prevent button failure.

In hard formations where the bit wears quickly, watch the size of the flats on the buttons. The buttons should be sharpened when the width of the flat is no wider than 1/2 the diameter to help prevent bit failure.

Some formations wash the steel away quickly. In this case the buttons start to protrude excessively. The buttons need to be ground down to prevent them from breaking off.

**Dull buttons are the single biggest contributor to slowed penetration and excessive stress to the bit and hammer.**

If a bit must be changed before a hole is complete, make sure the gage diameter of the bit used to complete the hole is no larger than the bit just removed. Using a larger bit will result in probable loss of the gage buttons before the bit reaches the bottom of the hole. For this reason, always keep 1 or 2 worn bits that are in good condition on the drill rig.

### 2.14 Breaking Threads Loose

When breaking the chuck thread loose to change bits, or the backhead loose to do hammer maintenance, follow these guidelines:

**ALWAYS USE A WRAP-AROUND WRENCH** this is to prevent pinching the sleeve out-of-round.

**KEEP SHARP JAWS IN THE WRENCH** the wear sleeve is very hard to give a long service life. Only quality hardened or diamond-tipped jaws in good condition will grip the sleeve.

**DO NOT WELD ON THE SLEEVE** welding on the hardened sleeve will crack the sleeve and voids any warranty on the sleeve.

PLACE THE WRENCH AS SHOWN BELOW

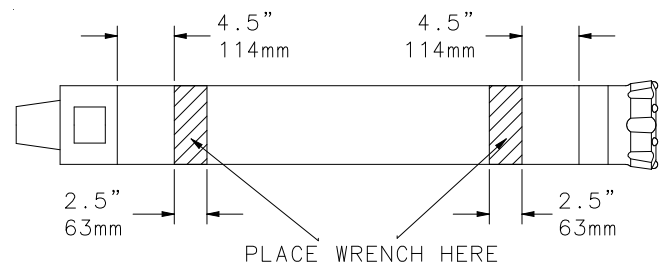



## 2.15 Monitoring

As the hammer accumulates drill time, these areas need to be monitored to determine when to service the hammer.

**External surfaces:** Rock Hog hammer parts are made from the best materials and hardened for long life but eventually these surfaces will wear away. The rate of wear depends on the formation being drilled, drilling speed and airflow. Make periodic checks to know what condition the parts are in.

Normally the chuck wears out first. Check the wall thickness on the bit shoulder end. When it measures 1/4" (6.3mm) or less at any point, replace the chuck. The service life of the chuck also heavily depends on the condition of the drill bit.

The wear sleeve will normally wear more on the chuck end. When the outside diameter reaches 4.38" (111.3mm), flip the sleeve. Once either end has worn down to a 4.18" (106.2mm) diameter, replace the sleeve. The service life of the sleeve also heavily depends on the condition of the chuck.

**Chuck splines:** check the condition of the chuck splines each time the bit is removed. **Do not put a chuck with badly worn splines on a new bit.**

**Shoulder Gap:** a hand-tight backhead will not be seated on the sleeve. Once torqued down, this gap will close and the backhead will seat on the sleeve. This clamps the internal parts to prevent part movement. Periodically check the gap between the sleeve and hand-tight backhead. If the gap falls below .08" (2.0mm), refer to Section 3.4-step 10.

**Operating pressure:** this is the best way to know what condition the internal parts are in. As internal parts wear, the operating pressure, and therefore the penetration rate, will drop. Only the operator can say when hammer performance has dropped below an acceptable level at which time the hammer must be serviced. If the pressure goes up after the hammer has been in service for some time, this would indicate the piston is sticking or the air passages inside the hammer are becoming restricted.

## 2.16 Storage

### Overnight

When drilling is complete for the day, shut off water and any other injections except the oil and allow air and oil only to blow through the hammer for a minute or two. This will blow out most of the water and other injections and coat all the internal parts with oil. **If the hammer is in a wet hole, bring the hammer above the water level before blowing it out.**

### Short term

If the hammer will be off the rig for no more than 3 weeks, blow air and oil only through the hammer for a minute or two before taking it off the rig. This will blow out most of the water and other injections and coat all the internal parts with oil. Store the hammer in a dry area with the ends covered. The storage area should have a steady temperature to prevent surface condensation during temperature swings.

### Long term

A used hammer going into storage for a month or more should be torn down with all parts cleaned, dried, oiled and stored assembled or disassembled in a dry, steady temperature area. This is to prevent surface corrosion. ***Surface corrosion is a main cause of part failure in hammers.***

## Section 3. Maintenance

### 3.1 Schedule

If the need for service defined in Monitoring, section 2.14, is not reached first, follow these guidelines for servicing the hammer:

When the hammer is operated to the parameters defined in section 2 in formations up to what is considered "hard", perform service every 25000 feet (7600 meters) of drilling.

When water injection & drilling foams are used extensively, perform service every 18000 feet (5500 meters).

When drilling in "very hard" formations or when drilling under heavy mud, perform service every 10000 feet (3000 meters).

When injecting agents that are corrosive to metal, like potash to coat the hole wall, clean the hammer at completion of the job.

**Use this as a starting point. Keep a log of service done-vs.-footage drilled. This will help refine the service schedule to fit your operation.**

### 3.2 Disassembly

All parts are a sliding or clearance fit inside the hammer. However, parts may be held by a retainer ring or may be tight inside the hammer depending on the condition of the parts and the time period since the hammer was last serviced.

1. Break both the backhead and chuck threads loose. See section 2.13.

2. Lay hammer on a bench, mark the sleeve ends "backhead" and "chuck".

3. Turn out the backhead, lift out the check valve, check valve spring and disc spring pack.

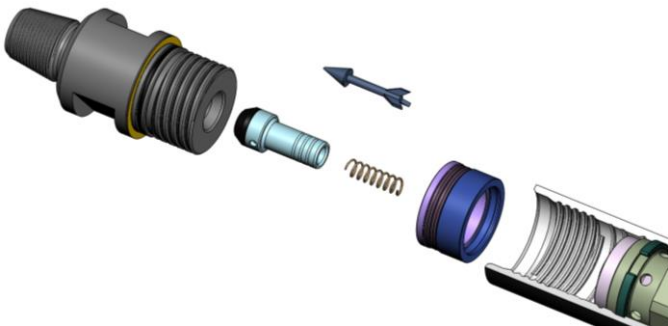

4. If the disc springs look dry and/or rusty, pull the disc spring pack apart. The guide ring is held inside the spacer tube by an o-ring. Hold the spacer tube and tap the guide ring out, remove the o-ring, slide the disc springs off the ring.

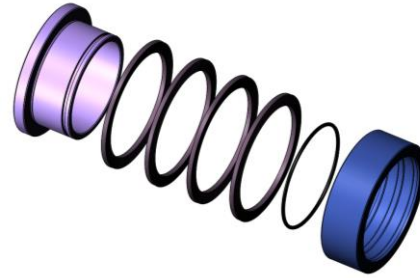

5. Turn out the chuck, lift out the bit retainer ring.

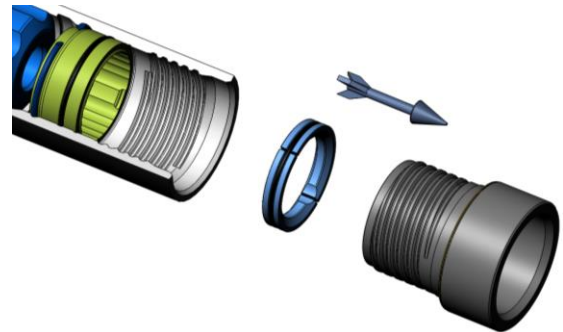

6. Drive out the air distributor from the chuck end with a steel rod or pipe (1" max dia x 30" min long). Run the rod through the piston to push out the air distributor.

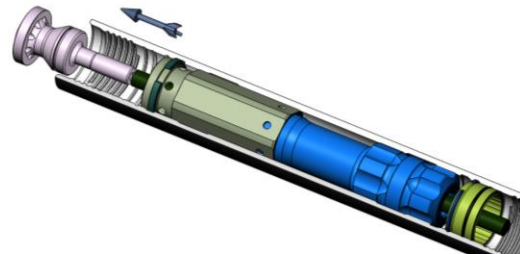

7. Remove the cylinder and piston. Stand the sleeve on the backhead end. The piston will drop against the cylinder. Using a rod, pipe, or timber (2-3/4" dia x 40" long) and a sledge hammer, or just a heavy bar (*Rock Hog uses a 2-1/2" dia x 5' long steel bar*), drive down on the piston. This will collapse the ring out of its groove and allow the cylinder and piston to move to the bottom of the sleeve. Lay the sleeve over and push the cylinder/piston out of the sleeve.

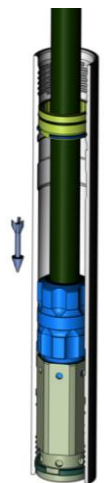

8. Removing the bearing. (Note: only the RH50Q uses a bearing. For the RH50R, go to step 9) An o-ring around the bearing is all that holds the bearing in. It may pull out by hand but most likely it will not and either method a. or b. can be used to remove the bearing. Use method-a if the piston is being removed. Use method-b if the backhead is not broke loose.

a. push method: Stand the sleeve on the chuck end. Drop the piston, small end first, into the backhead end of sleeve. This will push the bearing to the floor. Lay the sleeve over and push the bearing out, then push piston back out the backhead end.

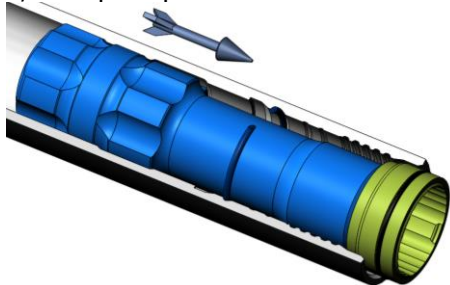

b. pull method: (this will allow the piston to be removed from the chuck end if the backhead is still tight) prepare a bump-out hammer from these parts:

+Block- 1/2 x 1-1/2 x 3-3/16 x 3-1/4 across corners, with a threaded center hole,

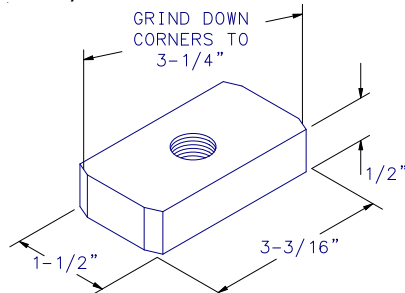

+threaded rod 24" long, nut, washer, and a slide hammer that will fit over the rod.

Pull out the bearing; To use the bump-out hammer, place the block behind the bearing on top of the piston, thread the rod into the block. Put the slide hammer, washer, and nut on the rod and pull the block up against the bearing. Keeping the block centered on the bearing, bump the bearing out of the wear sleeve.

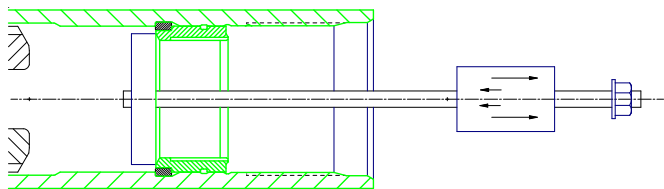

9. Remove the retaining ring. This ring does not need removed unless the wear sleeve needs flipped over, the ring is damaged, or the sleeve is being replaced.

If a hook tool is available, place the hook under the ring and pull it out of the groove.

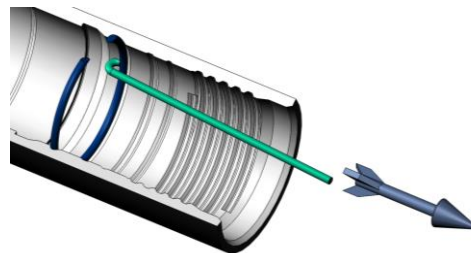

Or,

If a hook is not available, put the bit retainer ring and chuck back in, stand the sleeve on the chuck, and drop the piston, big end first, into the sleeve. The piston will push the ring down to the bit retainer ring (*installing the chuck and bit ret ring prevents the ring from getting pushed into the sleeve threads*). Then lay the sleeve back down, remove the chuck and bit ret ring, and push the piston back out.

*The piston has to drop freely through the sleeve for this to work. If the piston does not drop freely, push the piston down to the ring and then drive on the piston to push the ring out of its groove.*

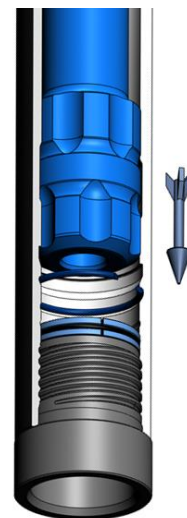

Now roll the ring up and pull it out of the sleeve.

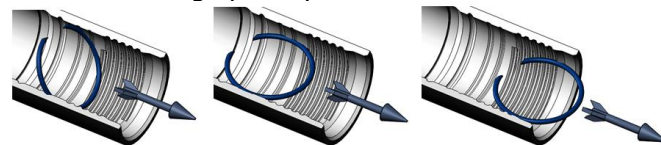

Disassembly is complete.

### 3.3 Inspection

Before cleaning any parts, observe them for oil. If the hammer is being properly lubricated, the parts should have a substantial film of oil all over but not dripping.

**None of the following should be found inside:**  
**dirt and grit**  
**metal shavings**  
**grease (other than at the chuck & backhead)**  
**rust and corrosion**

Clean all parts. Carefully look over all parts for cracks, corrosion, and pitting. Any corrosion indicates the hammer is not being oiled properly. Corrosion greatly increases the chance of cracks starting. Remove any and all corrosion using fine emery paper.

**Galling- is surface damage caused by metal-to-metal contact under high loads. Many of the parts listed will be checked for galling. Any sign of galling indicates lack of lubrication, use of the wrong type of lubricant, or parts have been damaged to the extent there is interference between parts.**

**Max Clearances:** Wear on the following part locations directly affect the hammer's operating pressure, and therefore the penetration rate. When clearances have reached the values given below, Rock Hog considers the part or parts worn out and recommends replacement. However, the hammer will continue to operate at clearances greater than those listed but at a greatly reduced efficiency. So only the operator can say when hammer performance has dropped below an acceptable level. Some operators may choose to replace parts before these limits have been reached to keep the hammer running at top performance.

#### Clearance 1: Piston OD to Sleeve ID .008

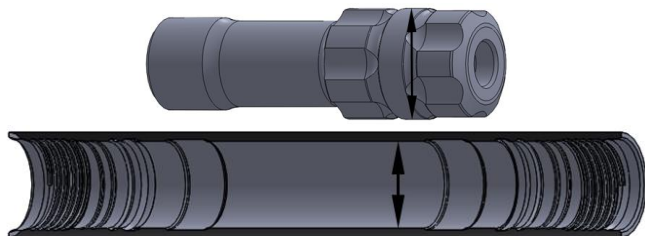

#### Clearance 2: Piston OD to Cylinder ID .009

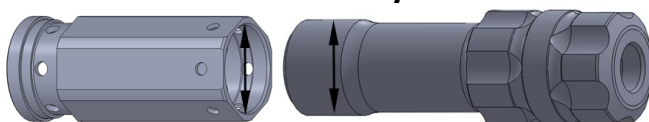

#### Clearance 3: Air Dist OD to Piston ID .009

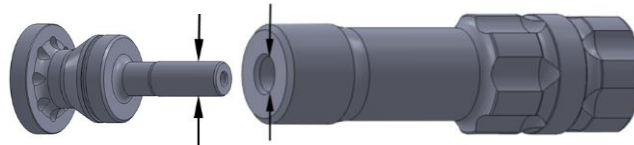

#### Clearance 4: Check Valve OD to Air Dist ID .009

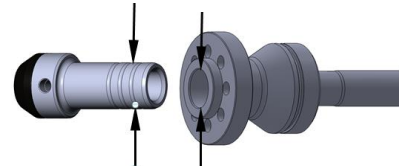

Clearance may be checked using feeler gages or by measuring both parts with micrometers. Additional details are given under individual parts below. Again, keeping a log of when & what service was performed will help fine-tune the service schedule to fit your operation.

**Backhead:** be sure to remove all the old grease from the drill pipe connection threads. Moisture can get trapped under the grease and corrode the surface. This also allows for a visual check of wear on the threads. Compare the worn threads to a new thread. If 50% of the thread form is worn away, replace the backhead.

Check the condition of the o-ring. If it is cracked, cut, or brittle, replace it.

Check the large threads for galling. Polish out any damaged areas.

**The outside of the backhead will wear away. This wear is not detrimental to the function of the hammer but will eventually allow the drill pipe to wear away. Replace the backhead if it is no longer protecting the drill pipe.**

**Check Valve:** check the condition of the rubber top. If the surface is degraded, replace the check valve. If the clearance with the air distributor bore is greater than .009" (.23mm), replace the check valve.

**Check Valve Spring:** the outside of the spring will be worn on one side about mid-length. If the wire diameter has been reduced by more than 30%, replace the spring.

**Dics Spring Pack:** Replace any parts that are cracked or damaged. In this case, the o-ring is not a seal but a retainer. Replace the o-ring if it no longer holds the pack together. If there is any rust on the disc springs, remove all the rust and put a coat of oil on the springs. Look for wear on the faces of the ring, spacer, and springs. As the faces wear, there is less compression force created by the springs. This compression is set by the compression gap described in section 3.4-step 10.

**Air Distributor:** make sure all the air holes are clear. Check the clearance of the stem end with the back bore in the piston. If it exceeds .009" (.23mm) replace the air distributor.

Check the condition of the o-ring. If it is cracked, cut, or brittle, replace it.

**Cylinder:** check the inside bore for galling with the piston. Polish out any surface damage.

Check the clearance of the bore with the top diameter of the piston. If it exceeds .009" (.23mm), replace the cylinder. Check the new cylinder to the used piston. If the clearance exceeds .006" (.15mm), replace the piston also.

Check the faces on the retaining ring in the outside groove. If the faces have a heavy step worn in them, cut off the ring and put on a new ring.

**Piston:** check the (2) outside guide diameters and top bore for galling and burning. Polish out any minor damage found on the surfaces.

Any black areas on the surface indicate the piston was rubbing and overheating. Surface heating is very detrimental to the piston. In most cases, if the surface is black, that surface will also be covered with cracks. Replace the piston if it has excessive surface cracks.

If the wear sleeve has not been previously flipped, check the clearance of the piston's big diameter with the sleeve bore where the cylinder sits. If it exceeds .006" (.15mm), replace the piston. Check the new piston to the sleeve 12"(305mm) in from the chuck end. If the clearance exceeds .006" (.15mm), flip the wear sleeve at assembly (note: normally sleeve external wear determines when the sleeve gets flipped).

If the sleeve has been previously flipped, check the clearance of the big diameter with the sleeve bore where the piston runs. If it exceeds .008" (.20mm), replace the sleeve. Check the piston to the new sleeve bore. If the clearance exceeds .006" (.15mm), replace the piston.

Check the strike face for chipping and pitting. Replace a piston with a badly damaged strike face.

**Note: the face can be reconditioned by removing up to .04" (1mm) of material. Only a qualified machinist should do this. Reconditioned pistons are not covered under warranty.**

Remove any nicks, dents, burrs with fine emery paper or a fine honing stone.

**Again look over the piston for any rust, corrosion, pitting. All these will lead to cracks and failure of the piston.**

**Wear Sleeve:** Check the outside diameter. The wear sleeve will normally wear more on the chuck end. When any location on the outside diameter has reached 4.38" (111.3mm), flip the sleeve. **Once any location**

**has worn down to a 4.18" (106.2mm) diameter, replace the sleeve.**

Check the bore where the piston runs and the threads for galling. Polish out any surface damage.

**Bearing (only the RH50Q uses a bearing):** check the inside bore for galling. Polish out any damage.

Check the clearance of the bore with the guide diameter of the bit. If it exceeds .010" (.25mm), replace the bearing.

**Chuck:** check the large threads for galling. Polish out any damaged areas.

Check the splines. The driving side will wear away. If the form of the driving side still matches the bit, the chuck is usable. If the form no longer matches the bit or more than ½ the spline thickness is worn away, replace the chuck.

Check the outside diameter for wear. If the wall thickness on the bit shoulder end measures 1/4" (6.3mm) or less at any point, replaced the chuck.

**Breakout Washers:** These copper washers are on the hammer when shipped. One between the backhead and sleeve, and one between the chuck and sleeve. The washers are optional but they do reduce the torque required to break the threads loose. These rings do disintegrate over time. During inspection there may be just a portion of the ring remaining or no ring at all.

### 3.4 Assembly

Any basic tools needed, will be described as needed.

**1. Make sure all parts are clean. Wash and wipe off and/or blow out any dirt. DIRT IN THE HAMMER WILL CAUSE THE PISTON TO STICK. Apply a light coat of oil to all internal parts.**

2. As determined from the inspection process, start with the chuck end. With the sleeve standing on the backhead end, install the round retainer ring if needed. With the ring opening down, push the ring into the first bore in the sleeve. While keeping the ring vertical, use a hammer or rod to tap the ring down to its location.

There are (2) locations for this ring. The 1<sup>st</sup> groove, 4-7/16" (113mm) down in, is for running 350 shank bits, hammer model RH50R. The 2<sup>nd</sup> groove, 6-1/16" (154mm) down in, is for running QL5 shank bits, hammer model RH50Q.

Tap the ring down until its center is just above the proper groove, then roll it over to horizontal and snap the ring into the groove.

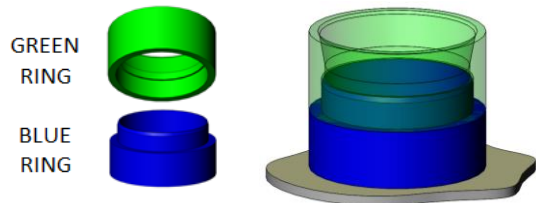
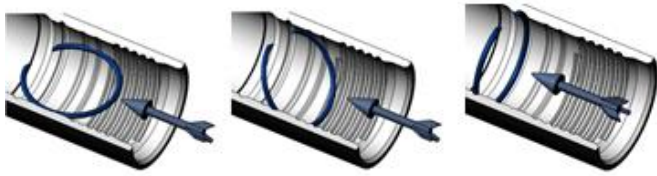

Set the cylinder into the ring stack, then set the piston down into the cylinder. Using the piston as a bump hammer, drive the cylinder into the ring stack until the cylinder hits the surface (*a few high-force blows with the piston work best*). Now pull the piston out of and slide the green ring off of the cylinder. The blue ring will stay on the cylinder keeping the cylinder retainer ring collapsed in the cylinder groove.

**3. Only the RH50Q uses a bearing. For the RH50R hammer, go to step 4.**

Installing bearing in RH50Q hammer. First apply some oil or grease to the o-ring to help it slide in. The bearing goes in with the scalloped inside diameter toward the sleeve. Push the bearing in by hand as far as possible. Set the piston on top of the bearing. The bearing is a slip fit. The only resistance to it going in is the drag of the o-ring. Using the piston as a bump hammer, tap the bearing in until it comes to a hard stop on the retainer ring. Pull out the piston.



4. Put o-ring around bit retainer ring halves. Set bit retainer ring in back to bearing. If used, put the breakout washer on the chuck and thread in the chuck. The chuck should seat up on the sleeve. If there is a gap, parts are out of place. Find the cause of the gap and correct it.

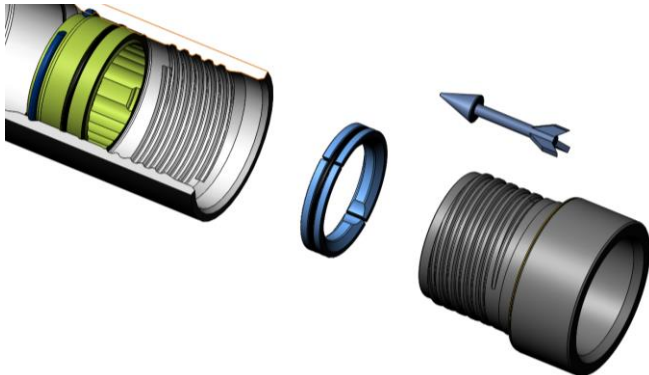

The bottom end is complete.

5. Prepare the cylinder and air distributor next. You will need the set of cylinder install rings. If you don't already have it, contact your Rock Hog rep. There is NO CHARGE for the rings. Stack them on a solid surface as shown here. The rings will be called out as blue and green.

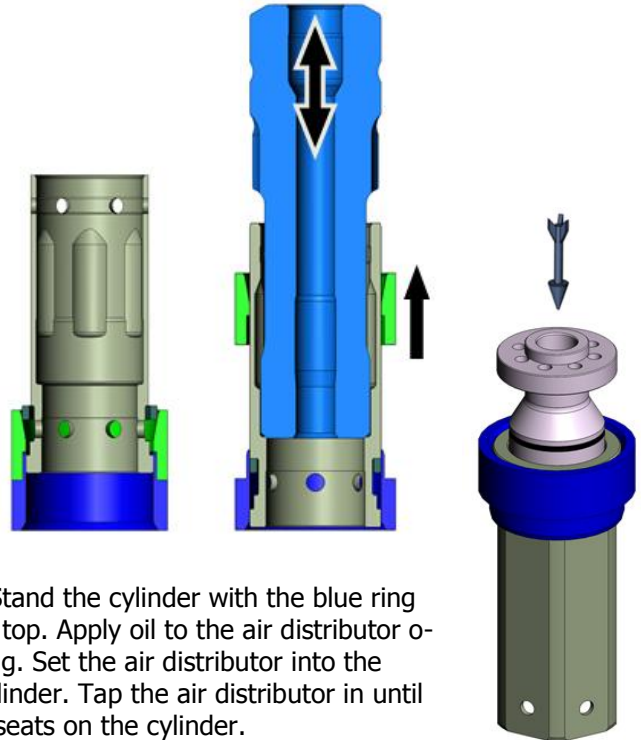

Stand the cylinder with the blue ring at top. Apply oil to the air distributor o-ring. Set the air distributor into the cylinder. Tap the air distributor in until it seats on the cylinder.

6. Apply film of oil to piston. Lay the sleeve horizontal and push piston, large end first, into the backhead end of the sleeve. The piston will hang up some as it passes the grooves but should then slide free to the bearing. If the piston does not slide free between the grooves, remove it and determine what is holding it up.

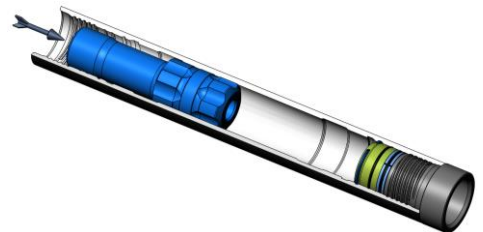

7. Install the cylinder/air distributor next: stand the hammer, chuck down, on a solid surface. Set the cylinder into the sleeve. Push/tap it in until the blue ring seats on the sleeve. Place a piece of soft steel, aluminum, or wood on top of the air distributor (*Rock Hog uses a piece of aluminum 2.5" round X 6" long*). With a sledge hammer, drive the cylinder/air distributor into the sleeve.

The ring will only seat into the correct location so drive the cylinder in until it comes to a hard stop. The top of the air dist will be below the sleeve 5.64" (143mm). Remove the blue ring and driver from the sleeve.

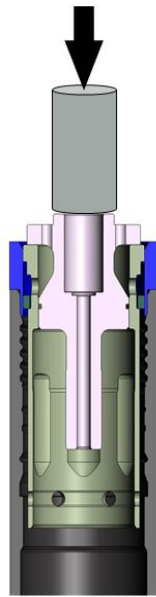

8. Put the spring pack together. The disc springs must be stacked as shown here. Grease the springs. Slide the springs over the guide, put the o-ring into the groove, tap the guide into the small side of the spacer.

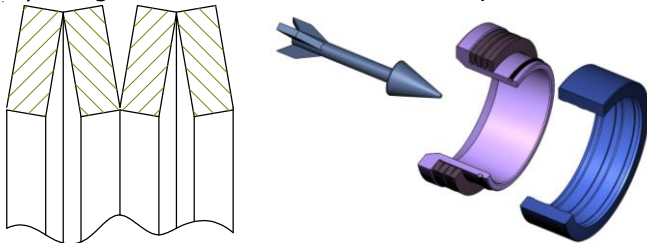

Set disc spring pack, spacer down, on top of the air distributor. **THE SPACER MUST BE TOWARD THE AIR DIST TO PREVENT BINDING OF THE DISC SPRINGS.**

9. Set the check valve spring, then the check valve into the air distributor center hole. Push check valve all the way down, the spring should push it back. **The valve must move freely.**

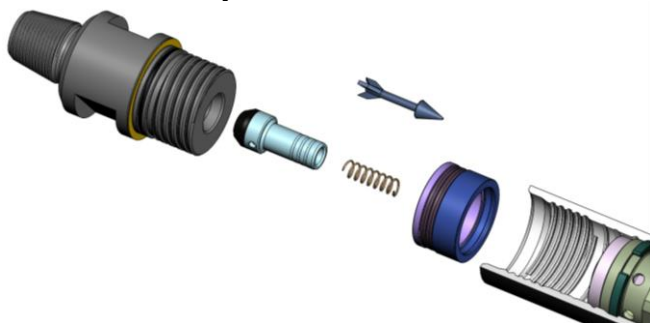

10. Check the backhead compression gap. This gap is critical for keeping the internal parts tight.

With the o-ring and breakout washer off of the backhead, thread the backhead into the sleeve until it is **hand-tight**.

Measure the gap between the backhead shoulder & sleeve face. If it is greater than .24" (6.0mm), a part is out of position. If it is less than .08" (2.0 mm), perform one of the following:

- Purchase and install Rock Hog part #943026 between the spring pack and air distributor
- Obtain and install a steel washer (3.69 OD x 2.90 ID x .090 THK) between the spring pack and air distributor

If the gap is less than .08 and a make-up washer is already in the hammer, replace the disc springs. Then check the condition of the cylinder retaining ring and the shoulders the ring sets on. Replace any worn parts. Assemble the hammer without the make-up washer, and check the gap. If the gap is still less than .08, put (1) new make-up washer back in.

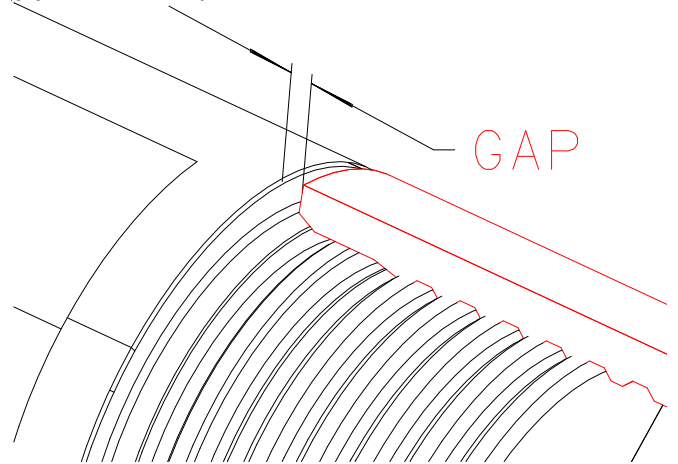

11. Once the gap is correct, remove the backhead, put the breakout washer on if used and put the o-ring on. Apply thick coating of copper coat grease to the backhead wear sleeve threads. Turn the backhead into the sleeve until hand tight. If available, put a thread protector cap on the drill pipe thread.

Assembly is complete.

## Section 4. Parts Breakdown

### Exploded View, model RH50Q1HP

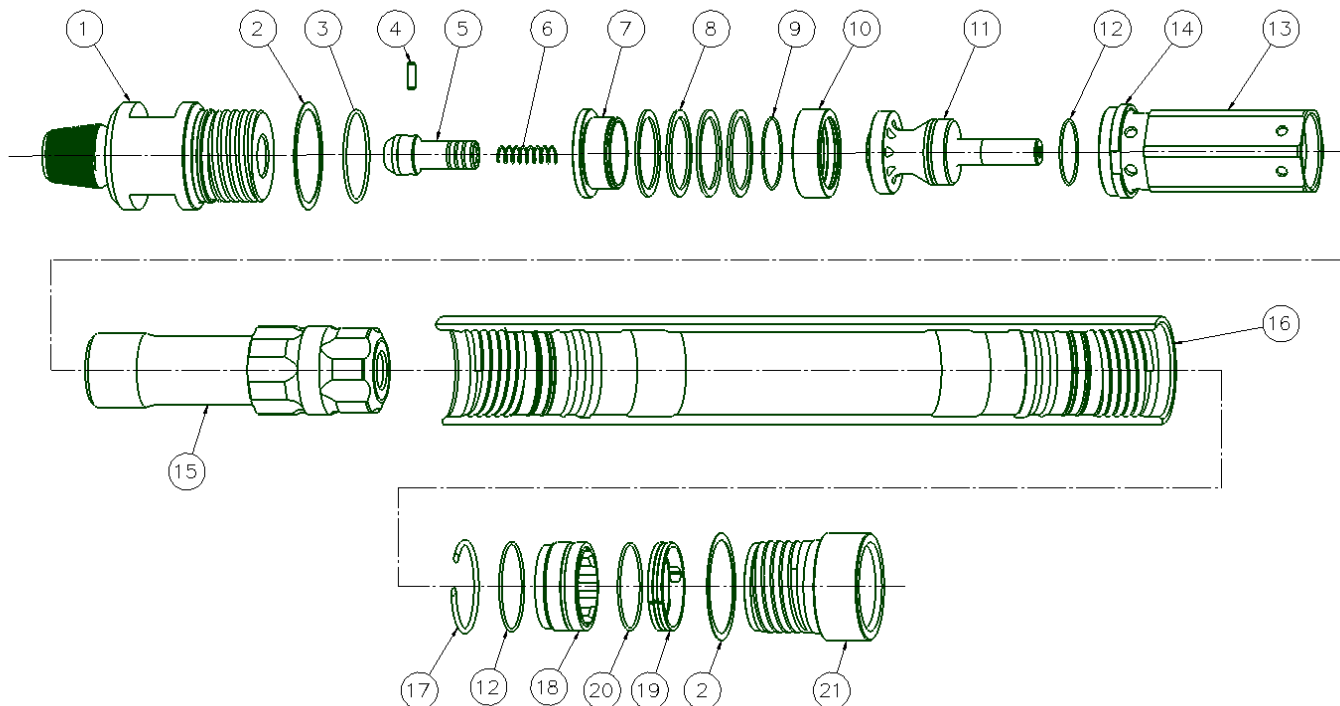

## Assembled View

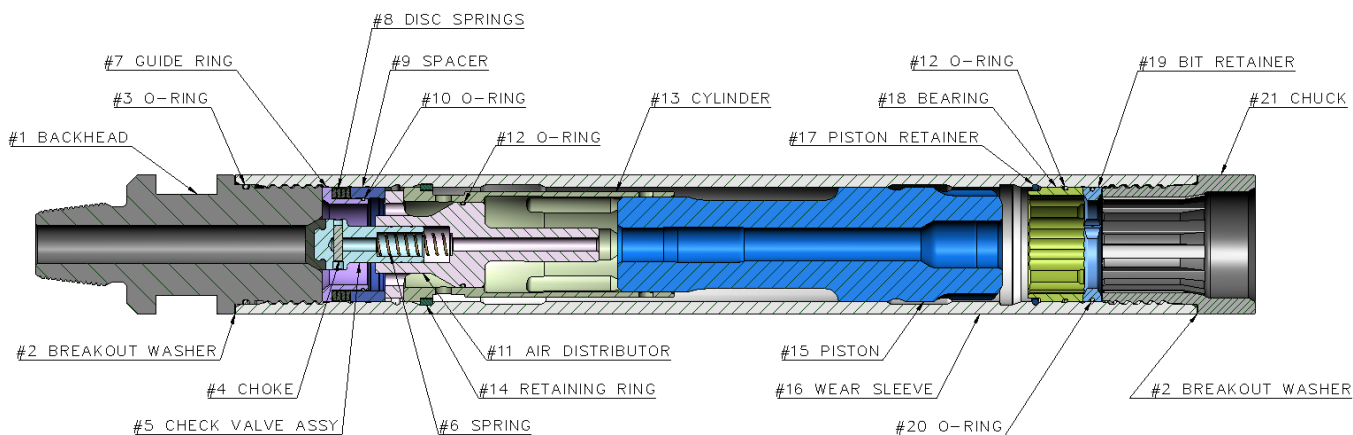



## Part List, Model RH50Q1HP

Shown at the right side of the chart is the quantity of spare parts that should be kept on hand. Level 1 is for water well drilling, Level 3 is for high production drilling.

ITEM No	PART No	QTY REQD	PART NAME	WEIGHT		SPARE PARTS ON HAND		
				LBS	KGS	LEVEL 1	LEVEL 2	LEVEL 3
1	062RH5Q1	1	BACKHEAD	30.5	13.9	-	-	1
2	943017	2	WASHER, BREAKOUT	0.03	0.0	-	2	4
3	560238	1	O-RING, BACKHEAD	0.01		1	2	4
4	1103810	1	CHOKE SET, SET OF 3	0.01		-	-	-
5	922RH6	1	CHECK VALVE, WITH SEAL CAP	0.58	0.26	-	-	1
6	798010	1	SPRING, CHK VAL	0.30	0.14	-	1	2
7	695015	1	GUIDE RING	0.90	0.41	-	-	-
8	799012	4	DISC SPRING	0.25	0.11	-	-	4
9	560143	1	O-RING, GUIDE RING	0.01		-	1	2
10	695025	1	SPACER RING	1.40	0.64	-	-	-
11	201RH50	1	AIR DISTRIBUTOR	4.50	2.05	-	-	1
12	560228	1	O-RING, AIR DIST	0.01		1	2	4
13	188RH50	1	CYLINDER, COMES WITH RING 14 INSTALLED	7.0	3.2	-	1	2
14		1	RETAINING RING, COMES ON CYLINDER 13	0.45	0.2	-	-	-
15	605RH50	1	PISTON	30.0	13.6	-	1	1
16	780RH50	1	WEAR SLEEVE	50.0	22.7	1	2	3
17	698058	1	RETAINING RING, PISTON/BEARING	0.14	0.064	-	-	-
18	065RH50	1	BEARING	1.00	0.455	-	1	1
19	698042	1	RETAINING RING, BIT	0.65	0.295	-	1	1
20	560235	2	O-RING, BIT RETAINING RING & BEARING	0.01		2	4	6
21	112RH5Q	1	CHUCK, QL5 BIT	7.9	3.6	2	4	6
<b>THE FOLLOWING PARTS ARE SOLD SEPARATE</b>								
-	943026		MAKEUP WASHER					1

- 454040 SET OF CYLINDER INSTALL RINGS AVAILABLE AT NO CHARGE

## Exploded View, model RH50R1HP

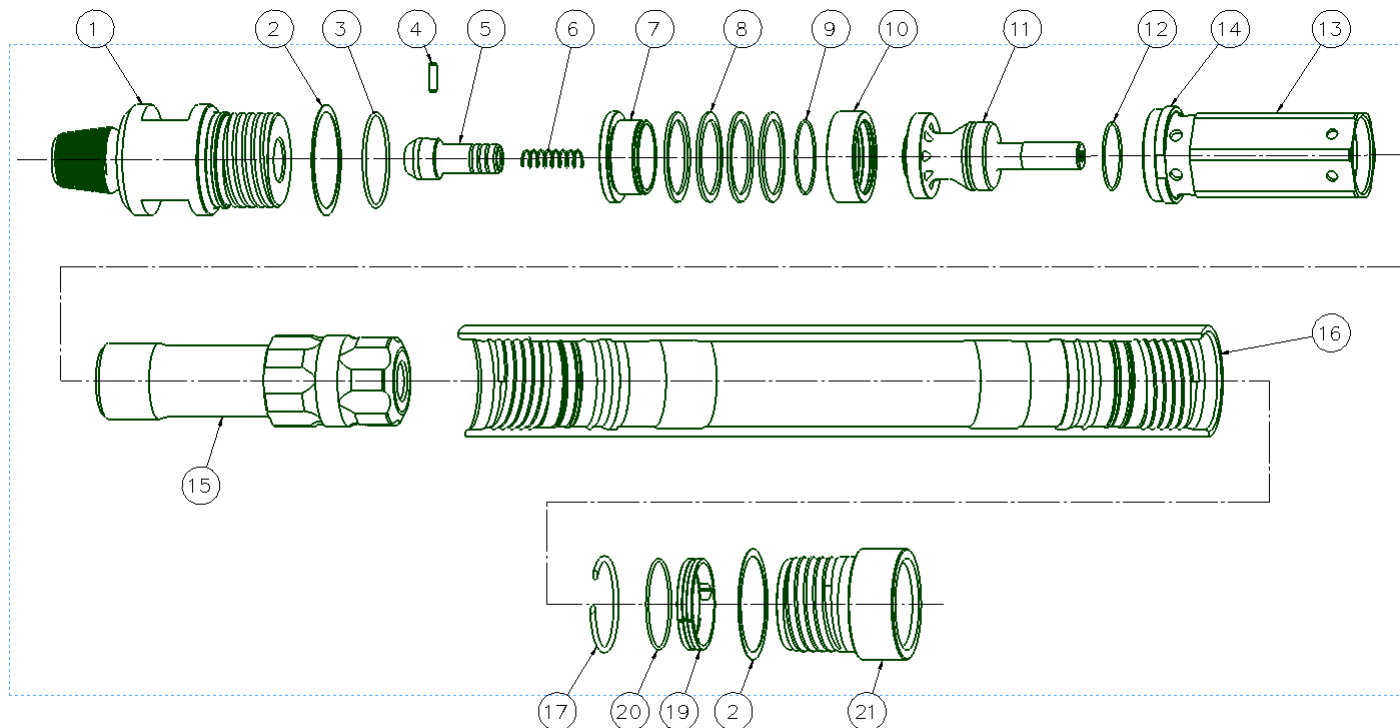

## Assembled View

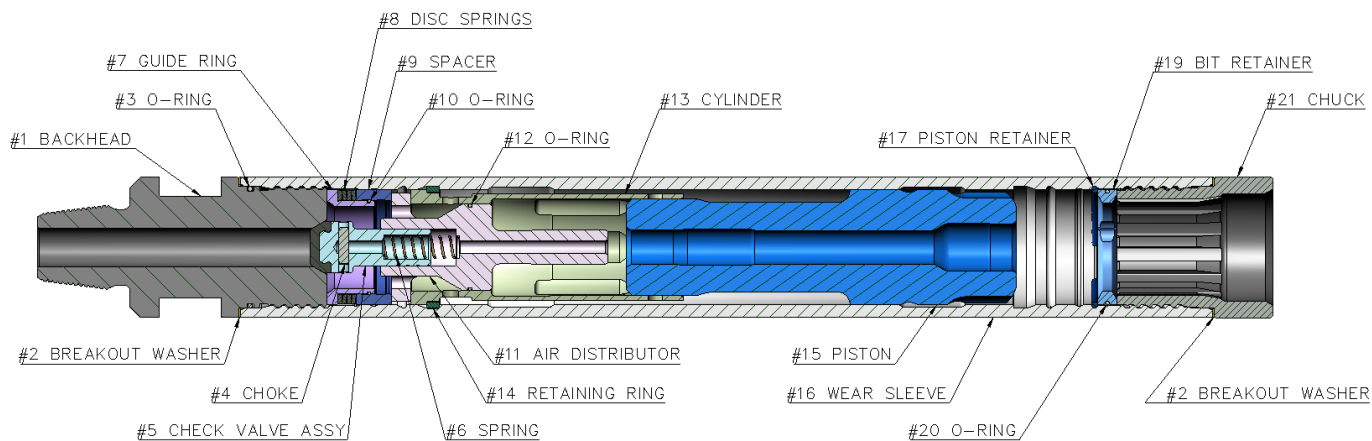

## Part List, Model RH50R1HP

Shown at the right side of the chart is the quantity of spare parts that should be kept on hand. Level 1 is for water well drilling, Level 3 is for high production drilling.

ITEM No	PART No	QTY REQD	PART NAME	WEIGHT		SPARE PARTS ON HAND		
				LBS	KGS	LEVEL 1	LEVEL 2	LEVEL 3
1	062RH5Q1	1	BACKHEAD	30.5	13.9	-	-	1
2	943017	2	WASHER, BREAKOUT	0.03	0.0	-	2	4
3	560238	1	O-RING, BACKHEAD	0.01		1	2	4
4	1103810	1	CHOKE SET, SET OF 3	0.01		-	-	-
5	922RH6	1	CHECK VALVE, WITH SEAL CAP	0.58	0.26	-	-	1
6	798010	1	SPRING, CHK VAL	0.30	0.14	-	1	2
7	695015	1	GUIDE RING	0.90	0.41	-	-	-
8	799012	4	DISC SPRING	0.25	0.11	-	-	4
9	560143	1	O-RING, GUIDE RING	0.01		-	1	2
10	695025	1	SPACER RING	1.40	0.64	-	-	-
11	201RH50	1	AIR DISTRIBUTOR	4.50	2.05	-	-	1
12	560228	2	O-RING, AIR DIST.	0.01		2	4	6
13	188RH50	1	CYLINDER, COMES WITH RING 14 INSTALLED	7.0	3.2	-	1	2
14		1	RETAINING RING, COMES ON CYLINDER 13	0.45	0.2	-	-	-
15	605RH50R	1	PISTON	30.0	13.6	-	1	1
16	780RH50	1	WEAR SLEEVE	50.0	22.7	1	2	3
17	698058	1	RETAINING RING, PISTON	0.14	0.064	-	-	-
18			<i>part not used in this hammer</i>					
19	698042	1	RETAINING RING, BIT	0.65	0.295	-	1	1
20	560235	1	O-RING, BIT RETAINING RING	0.01		1	2	4
21	112RH50R	1	CHUCK, 350 BIT	11.0	5.0	2	4	6
<b>THE FOLLOWING PARTS ARE SOLD SEPARATE</b>								
-	943026		MAKEUP WASHER					1

## Section 5. Trouble Shooting

These are typical problems that can develop after the hammer has been in service:

### Possible Causes

#### **Piston will not cycle**

1. Piston stuck in sleeve due to
  - a. Sleeve was pinched shut with wrench when threads were being loosened/tightened
  - b. Foreign material entered through drill string and jammed piston
  - c. Mud backed up into hammer (drilling under water), inspect the check valve
2. An internal part failed

#### **Slow penetration, pressure ok**

1. Dull or broken buttons on bit
2. Incorrect drill rotation or down pressure for the formation being drilled
3. Harder rock formation than the normal

#### **Low pressure**

1. Leak in the air line
2. Leak in the hammer (cracked or broken part)
3. Compressor output problem

#### **High pressure**

1. Air line is partially closed off
2. Foreign material clogging air passages in hammer
3. Bit blow holes are clogged